



77411-00 pump drive

Model Nos.

N° de modèle

Modellnummer

Número de modelo

Modello n°

77410-10

77411-00

**OPERATING MANUAL:
PUMP DRIVES**

pages 1-10

**MODE D'EMPLOI:
ENTRAÎNEMENTS
DE POMPES**

F1-F10

**BETRIEBSANLEITUNG:
PUMPENANTRIEBE**

D1-D10

**MANUAL DE FUNCIONAMIENTO:
MOTOR DE BOMBAS**

E1-E10

**MANUALE DI ISTRUZIONI:
UNITÀ DI
CONTROLLO POMPA**

T1-T10



Cole-Parmer Instrument Co.

1-800-MASTERFLEX (627-8373) (U.S. and Canada only)

11 (847) 549-7600 (Outside U.S.) • (847) 549-7600 (Local) • www.masterflex.com

ISO9001:2000
SUPPLIER CERTIFIED

**Barnant
Company**

Barnant Company

1-800-637-3739 (U.S. and Canada only)

11 (847) 381-7050 (Outside U.S.) • (847) 381-7050 (Local) • www.barnant.com

ISO9001:2000
REGISTERED SUPPLIER

A-1299-1037

Edition 02

TABLE OF CONTENTS

Title

SAFETY PRECAUTIONS2

INTRODUCTION3

CONTROL/DISPLAY FUNCTIONS3

SETUP AND DRIVE OPERATION3

 Automatic Start Enable/Disable4

REMOTE CONTROL5

 Remote Control Setup5

 Internal / External Operation5

TROUBLESHOOTING AND MAINTENANCE7

 Fuse Replacement7

 Troubleshooting7



 Cleaning8

 Replacement Parts and Accessories8

SPECIFICATIONS9

TECHNICAL ASSISTANCE10

SAFETY PRECAUTIONS

<p>WARNINGS:</p> <p></p>	<p>No user serviceable parts inside. Do not remove covers. Refer servicing to your dealer.</p> <p>Tubing breakage may result in fluid being sprayed from pump. Use appropriate measures to protect operator and equipment.</p> <p>Turn drive off before removing or installing tubing. Fingers or loose clothing could get caught in drive mechanism.</p>
<p></p>	<p>To avoid electrical shock, the power cord protective grounding conductor must be connected to ground. Not for operation in wet locations as defined by EN 61010-1.</p>
<p>CAUTIONS:</p> <p></p>	<p>Do not stack drives. Keep 3" minimum distance around and above drive for proper cooling.</p>

<p>WARNING:</p> <p></p>	<p>PRODUCT USE LIMITATION</p> <p>This product is not designed for, nor intended for use in, patient-connected applications, including, but not limited to, medical and dental use, and, accordingly, has not been submitted for FDA approval. If drive is used in a manner not specified in this manual the protection provided by the equipment may be impaired.</p>
-------------------------------------------------------------------------------------------------------------------	------------------------------------------------------------------------------------------------------------------------------------------------------------------------------------------------------------------------------------------------------------------------------------------------------------------------------------------------------------------------------

INTRODUCTION

The brushless drive controls the speed of Masterflex® I/P® pump heads to provide variable flow rates from 0.2 to 17 L/min (0.06 to 4.5 gallons/min). Achieve up to 26 LPM (7 GPM) with two stacked Standard or EASY-LOAD® I/P® pump heads. One Masterflex® High-Performance I/P® pump head may be driven.

CONTROL/DISPLAY FUNCTIONS

Press keys to activate function.

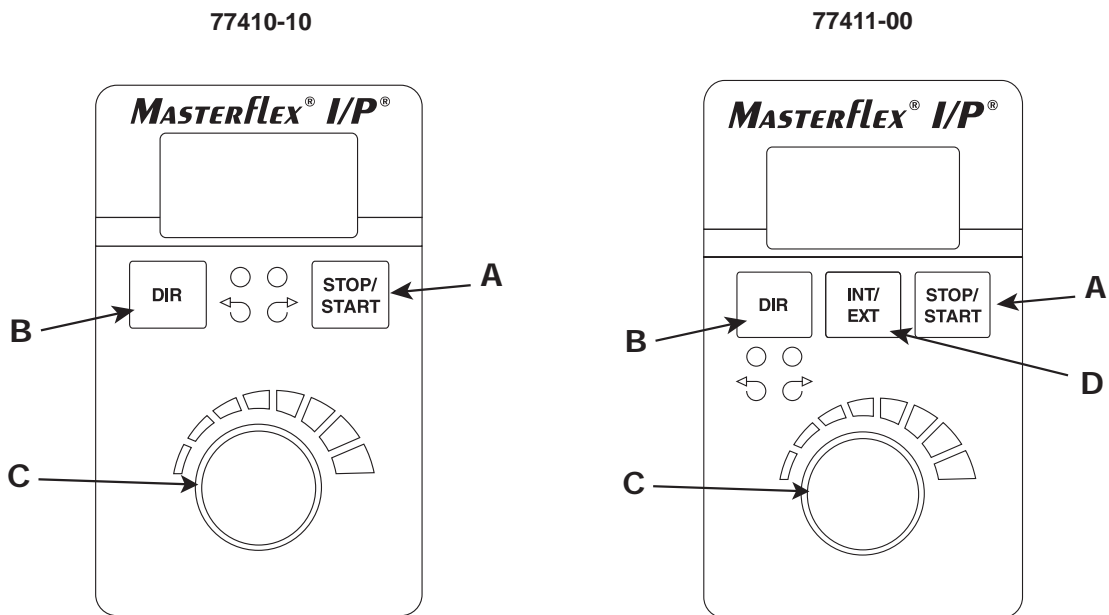

Figure 1

- A. STOP/START**—Start/Stop pump.
- B. DIRECTION**—To change motor direction.
- C. SPEED**—Selects output speed from 5 to 100% Full Scale (33 to 650 RPM). Clockwise rotation increases speed.
- D. INT/EXT**—(Model 77411-00 only) INT for internal control; EXT for remote current or voltage control.

SETUP AND DRIVE OPERATION

1. Attach any external control connections. (Model 77411-00 only)
2. Mount pump head and load tubing (see pump head manual).

NOTE: *The High-Performance I/P® pump is mounted with the tubing to the left. The Standard I/P® pump is mounted with the tubing up. The Easy-Load® I/P® pump is mounted with the occlusion bed up.*

3. Turn drive on.
4. Select INTernal or EXTernal operation. (Model 77411-00 only)
5. Select pump DIRection (clockwise or counter-clockwise).
6. Press STOP/START key to begin pumping.
7. Adjust speed (listed flow rates are for reference only. Flow will vary with pressure, tubing, viscosity, and time):

Speed Setting	I/P® 26	I/P® 73	I/P® 82	I/P® 70	I/P® 88	I/P® 89
10%	0.4 LPM 0.11 GPM	0.8 GPM 0.21 GPM	1.3 LPM 0.35 GPM	0.8 LPM 0.21 GPM	1.3 LPM 0.35 GPM	1.7 LPM 0.45 GPM
20%	0.8 LPM 0.22 GPM	1.6 LPM 0.42 GPM	2.6 LPM 0.70 GPM	1.6 LPM 0.42 GPM	2.6 LPM 0.70 GPM	3.4 LPM 0.90 GPM
30%	1.2 LPM 0.33 GPM	2.4 LPM 0.63 GPM	3.9 LPM 1.05 GPM	2.4 LPM 0.63 GPM	3.9 LPM 1.05 GPM	5.1 LPM 1.35 GPM
40%	1.6 LPM 0.44 GPM	3.2 LPM 0.84 GPM	5.2 LPM 1.40 GPM	3.2 LPM 0.84 GPM	5.2 LPM 1.40 GPM	6.8 LPM 1.80 GPM
50%	2.0 LPM 0.55 GPM	4.0 LPM 1.05 GPM	6.5 LPM 1.75 GPM	4.0 LPM 1.05 GPM	6.5 LPM 1.75 GPM	8.5 LPM 2.25 GPM
60%	2.4 LPM 0.66 GPM	4.8 LPM 1.26 GPM	7.8 LPM 2.1 GPM	4.8 LPM 1.26 GPM	7.8 LPM 2.1 GPM	10 LPM 2.70 GPM
70%	2.8 LPM 0.77 GPM	5.6 LPM 1.47 GPM	9.1 LPM 2.45 GPM	5.6 LPM 1.47 GPM	9.1 LPM 2.45 GPM	12 LPM 3.15 GPM
80%	3.2 LPM 0.88 GPM	6.4 LPM 1.68 GPM	10 LPM 2.8 GPM	6.4 LPM 1.68 GPM	10 LPM 2.8 GPM	14 LPM 3.60 GPM
90%	3.6 LPM 0.99 GPM	7.2 LPM 1.89 GPM	12 LPM 3.15 GPM	7.2 LPM 1.89 GPM	12 LPM 3.15 GPM	15 LPM 4.05 GPM
100%	4 LPM 1.1 GPM	8 LPM 2.1 GPM	13 LPM 3.5 GPM	8 LPM 2.1 GPM	13 LPM 3.5 GPM	17 LPM 4.5 GPM

NOTE: *While in INTernal mode, drive will automatically restart after a brownout or power out condition unless operator changes default setting. If speed is being controlled by an external signal, drive will automatically restart with a non-zero speed command.*

AUTOMATIC START ON/OFF (Internal mode only)

Press and hold DIR on power-up. After five (5) seconds, display will read "ON" (factory default) or "OFF". Hold the DIR key for an additional 3 seconds and the display will toggle to the other option every 3 seconds. Release the DIR key when the desired mode is being displayed. After releasing the key, "ON" or "OFF" will remain displayed for about 3 seconds and then the normal power-on sequence will begin. When "ON" is selected, drive will start automatically at power-up if it was running when powered down.

REMOTE CONTROL (Model 77411-00 only)

- Selectable input (4–20 mA, 0–10V DC)
- $\pm 0.5\%$ linearity control
- $\pm 50V$ common mode range with respect to earth ground
- Internal & External START/STOP; External CW/CCW via contact closure

REMOTE CONTROL SETUP

1. Place the power switch in the off position.
2. Connect the cable from the external remote control to the mating receptacle on the rear panel.
3. Select operation from front panel potentiometer, external 4-20mA current source, or external 0-10 V voltage source as follows:
 - a. Press and hold the INT/EXT control for approximately 5 seconds until the present setting of the speed source is displayed.
 - b. Continuing to hold the INT/EXT control will cause the display to cycle through the three choices: "4.20" indicating the 4-20 mA input, "0.10" indicating the 0-10 V input, or "Pot" indicating that the Speed Input Potentiometer will be used. When the key is released, the programmed choice will remain on the display for approximately 3 seconds as confirmation of the speed source choice made before returning to normal operation.
4. To adjust the voltage or current scaling for other than zero to full scale:
 - a. Press and hold the INT/EXT control (approximately 5 seconds) until the external speed source is displayed. ("4.20", "0.10", or "Pot")
 - b. Release the INT/EXT control and press the DIR control before the external speed source disappears from the display.
 - c. The display will show "Lo" for about 3 seconds and then flash the current speed setting for the low set point (4 mA or 0 V). To change this setting, adjust the Speed Control Potentiometer to the percent of full speed desired. To make no change, press the DIR control a second time.
 - d. After pressing the DIR control the second time, the display will show "Hi" and then flash the high (20 mA or 10 V) speed set point. This can be changed by adjusting the Speed Control Potentiometer, or left as is by pressing the DIR control again.
 - e. The third press of the DIR control returns the drive to normal operation.

NOTE: *The 4-20 mA input, the 0-10 V input, and the 4-20 mA output are not scaled separately.*

INTernal / EXTernal Operation

1. The EXTernal mode of operation enables the PUMP READY output, the EXTERNAL START/STOP, EXTERNAL CW/CCW, 4-20 mA, and 0-10 V inputs, while disabling the INTERNAL START/STOP input (e.g. footswitch) and front-panel DIR and START controls. The pump speed is determined by the programmed choice of 4-20 mA, 0-10 V, or front panel potentiometer inputs. The front panel STOP/START control overrides the EXTERNAL START/STOP input to stop the drive.
2. In the INTernal mode of operation, either the INTERNAL START/STOP input (e.g. footswitch) or the front panel STOP/START control can start or stop the drive at the speed set by the front-panel SPEED POT.

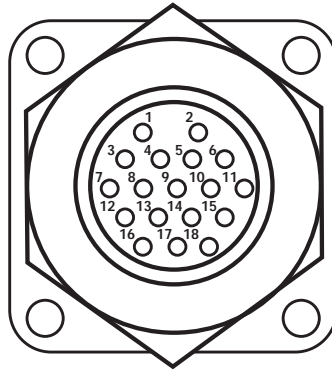
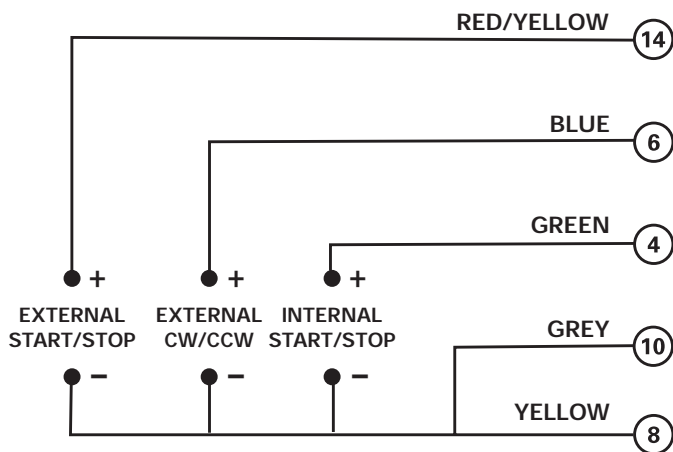
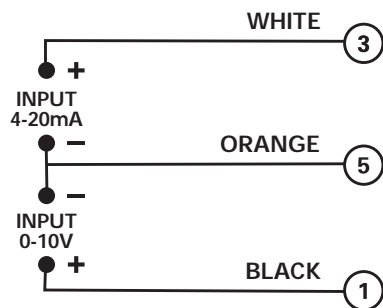

Figure 2



NOTE: Colors are those of Remote Cable.
Catalog number 77300-32



⑫ TAN
(RESERVED)

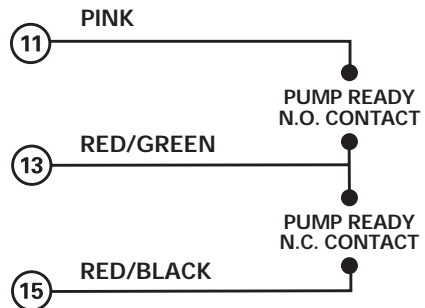

⑬ N.C.

⑭ N.C.

⑮ RED
(RESERVED)

⑯ N.C.

TROUBLESHOOTING AND MAINTENANCE

FUSE REPLACEMENT

- 1 Place the power switch in the off position.
- 2 Disconnect the AC power input line cord from the attached line and receptacle.
- 3 Remove and check the fuse and replace if defective
- 4 Reconnect the AC power input line cord to the receptacle.

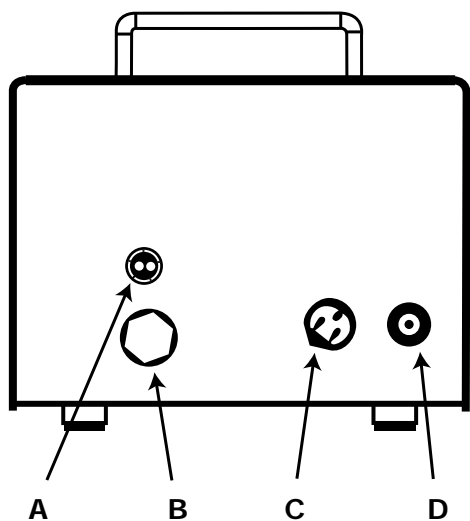

Figure 3

- A. T6.3A Fuse (CAUTION: Do not substitute.)
- B. External receptacle for remote control
- C. IEC 320 Power cord
- D. Power switch

TROUBLESHOOTING

SYMPTOM	CAUSE	REMEDY
A Motor does not rotate Display does not light	A No power	<ol style="list-style-type: none"> 1 Check fuse and replace if defective (Fig. 3) 2 Check that unit is plugged into a live line 3 Check connection of power cord 4 Check the line cord for continuity and replace if defective 5 Return for servicing
B Motor does not rotate Display lights	B1 Defective remote control	<ol style="list-style-type: none"> 1 Place power switch in off position 2 Check that remote cable connector is inserted fully into the receptacle (Fig. 2 and 3) 3 If motor still does not rotate, select INTernal with the INT/EXT control and press the STOP/START control (Fig. 1) 4 If the motor rotates, replace the remote control with similar unit. If motor does not rotate, return drive for servicing
	B2 INT/EXT control not properly set	<ol style="list-style-type: none"> 1 Check that the INT/EXT control is set to INT for operation with front panel control or to EXT for with operation remote control (Fig. 1) 2 If motor still does not rotate, return for servicing

Troubleshooting continued on page 8

TROUBLESHOOTING (Continued)

If an error message is displayed, refer to the following list for possible corrective actions you can take. If these do not correct the problem, contact your dealer.

ERROR MESSAGE	CAUSE	REMEDY
"Err 2"	Motor over-speed	<ol style="list-style-type: none"> 1 Clear by pressing any key 2 Check for proper tube loading and pump operation 3 Return unit for repair if the error persists
"Err 3" "Err 5" "Err 12"	Overload	<ol style="list-style-type: none"> 1 Clear by pressing any key 2 Check for proper tube loading and pump operation 3 Return unit for repair if the error persists
"Err 7"	Bad data Operator parameters set to default values	<ol style="list-style-type: none"> 1 Clear by pressing any key 2 Reprogram operator parameters 3 Return unit for repair if the error persists
"Err 10" "Err 11"	Voltage out of range	<ol style="list-style-type: none"> 1 Clear by pressing any key 2 Check that AC line voltage is within specified voltage ranges 3 Return unit for repair if AC line voltage is correct and the error persists
"Err 13" "Err 14"	Over temperature	<ol style="list-style-type: none"> 1 Check for heat sources or obstructions to cooling 2 Check for proper tube loading and pump operation 3 Allow unit to cool Clear by pressing any key 4 Return unit for repair if no cause for overheating is found and the error persists
All other errors	Internal error or failure	<ol style="list-style-type: none"> 1 Clear (if possible) by turning power off and on 2 Return unit for repair if the error persists

CLEANING

Keep the drive enclosure clean with mild detergents. Do not immerse.

REPLACEMENT PARTS & ACCESSORIES

77500-24	Fuse—T6.3A 5 x 20 mm
07595-43	Footswitch
77300-32	Remote control cable, 25 ft (7.62 m)

SPECIFICATIONS

OUTPUT

Speed:	33 to 650 rpm
Torque output, maximum:	
Continuous	540 oz-in (39 kg-cm) @ 25°C Ambient 380 oz-in (27 kg-cm) @ 40°C Ambient
Start-up	960 oz-in (69 kg-cm)
Speed regulation:	
Line	±0.25% F.S.
Load	±0.25% F.S.
Drift	±0.25% F.S.
Display:	Three-digit, seven-segment LED
Remote outputs:	Current speed output (4–20 mA @ 0–600 Ω) Pump ready output (N.O. & N.C. contact closure, 1A @ 28V AC/DC)
(Model 77411-00 only)	

INPUT

Supply voltage limits:	Universal Input - 90 to 260 Vrms @ 50/60 Hz, Single Phase
Current, maximum	4.5A @ 115 Vrms, or 2.6A @ 230 Vrms
Remote Inputs:	Internal & External START/STOP (Contact closures) External CW/CCW (Contact closure)
(Model 77411-00 only)	Voltage input (0–10V DC @ 10 kΩ) Current input (4–20 mA @ 250 Ω)

CONSTRUCTION

Dimensions (L x W x H):	14.0" x 10" x 9.1" (35 cm x 25 cm x 23 cm)
Weight:	22 lb (10 kg)
Enclosure rating:	IP55 per IEC 60529

ENVIRONMENT

Temperature, operating:	0 to 40°C (32 to 104°F)
Temperature, storage:	-25 to 65°C (-13° to 149°F)
Humidity (non-condensing):	10 to 100%
Altitude:	Less than 2000 m
Pollution degree:	Pollution Degree 3 (Indoor use—sheltered locations)
Chemical resistance:	Enclosure is painted steel

COMPLIANCE

UL508C, CSA C22.2, No. 14
(For CE Mark):
EN61010-1 (EU Low Voltage Directive) and
EN61326 (EU EMC Directive)

TECHNICAL ASSISTANCE

If you have any questions about the use of this product, contact the Manufacturer or authorized seller.

Cole-Parmer Instrument Co.

625 East Bunker Court
Vernon Hills, Illinois U.S.A. 60061-1844
1-800-MASTERFLEX (627-8373)
(U.S. and Canada only)
11-847-549-7600 *(Outside U.S.)*
847-549-4600 *(Local)*
FAX 847-247-2929 *(U.S. and Canada only)*
11-847-549-1700 *(Fax outside U.S.)*
www.masterflex.com
e-mail:techinfo@coleparmer.com



Barnant Company

28W092 Commercial Ave.
Barrington, Illinois U.S.A. 60010-2392
1-800-637-3739 *(U.S. and Canada only)*
11-847-381-7050 *(Outside U.S.)*
847-381-7050 *(Local)*
FAX 11 847-381-7053 *(Fax outside U.S.)*
847-381-7053 *(Local Fax)*
www.barnant.com
e-mail:barnant@barnant.com

